

Introduction to Altium Designer 15.1

Prepared by:

Mahyar Bayran

Principles of Electronics

Sharif University of Tech.

Fall 2015

Content

- Goals
- Intro
- Creating PCB Project ,Schematic and PCB
- Adding Libraries
- Designing Schematics
- Designing PCB
- Common errors and tips
- Guide to online ordering a PCB
- References

Goals

- ⊕ Ability to design simple Schematic and PCB.
- ⊕ Earn sufficient skills to do your course projects.
- ⊕ Learn common errors.

Altium and PCB

- **Altium Designer** is an electronic design automation software package for printed circuit board, FPGA and embedded software design, and associated library and release management automation.
- A **Printed Circuit Board (PCB)** mechanically supports and electrically connects electric components using conductive tracks, pads and other features etched from copper sheets laminated onto a non-conductive substrate.

Early PCBs

- Before the advent of the PCB, circuits were constructed through a laborious process of point-to-point wiring.
- This led to frequent failures at wire junctions and short circuits when wire insulation began to age and crack.

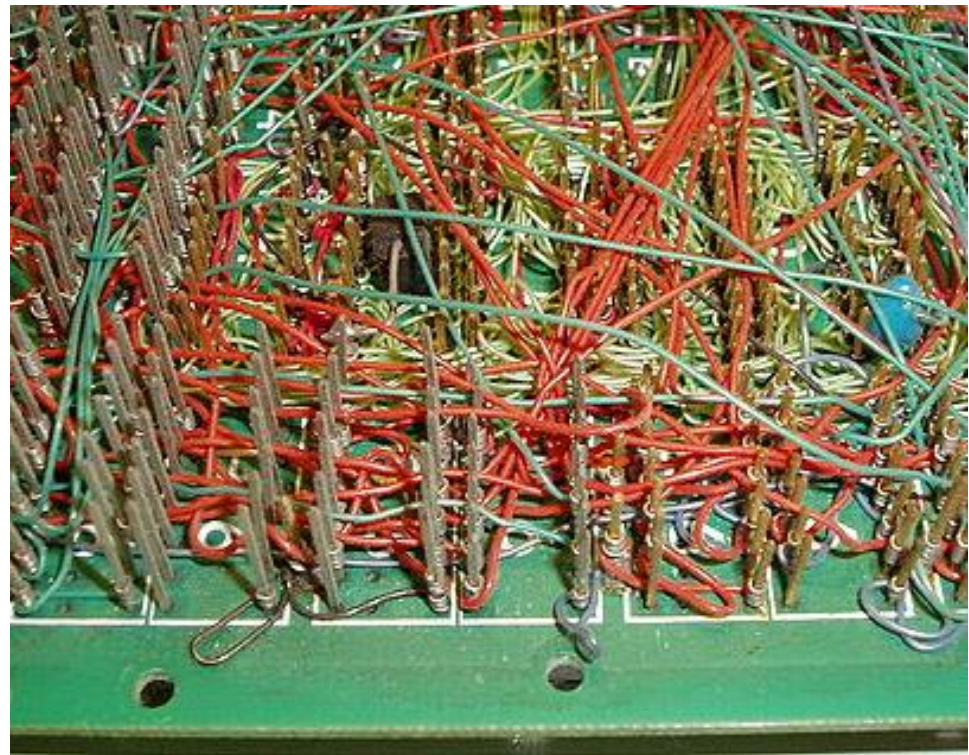

PCB samples

- You can see samples of Printed Circuit Board (PCB) at below: (holes are connected with conductive tracks)

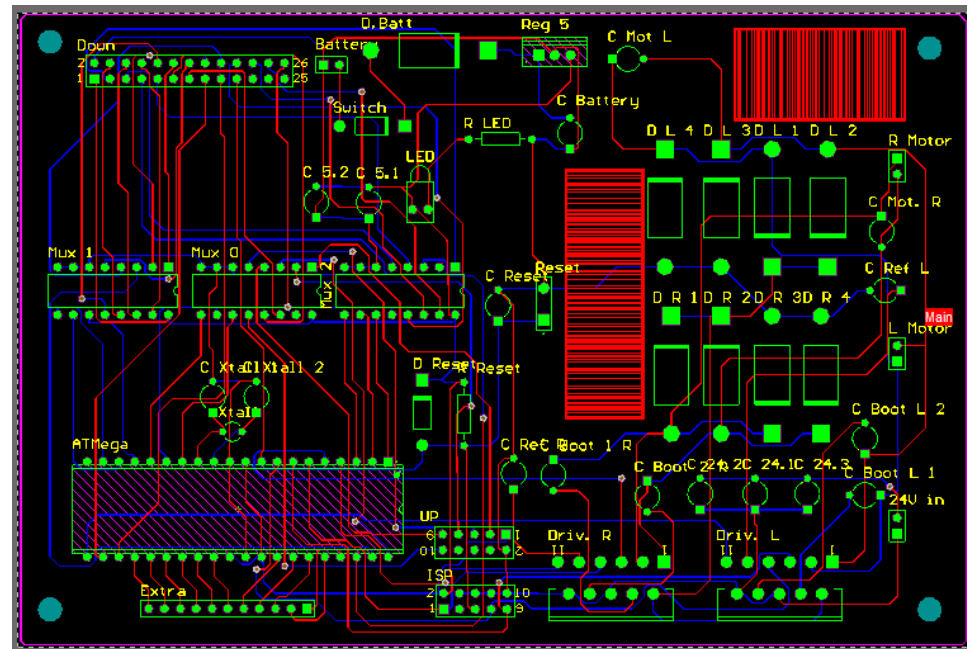

PCB fabrication process

- The complicated process of PCB fabrication can be summarized into this flow chart:

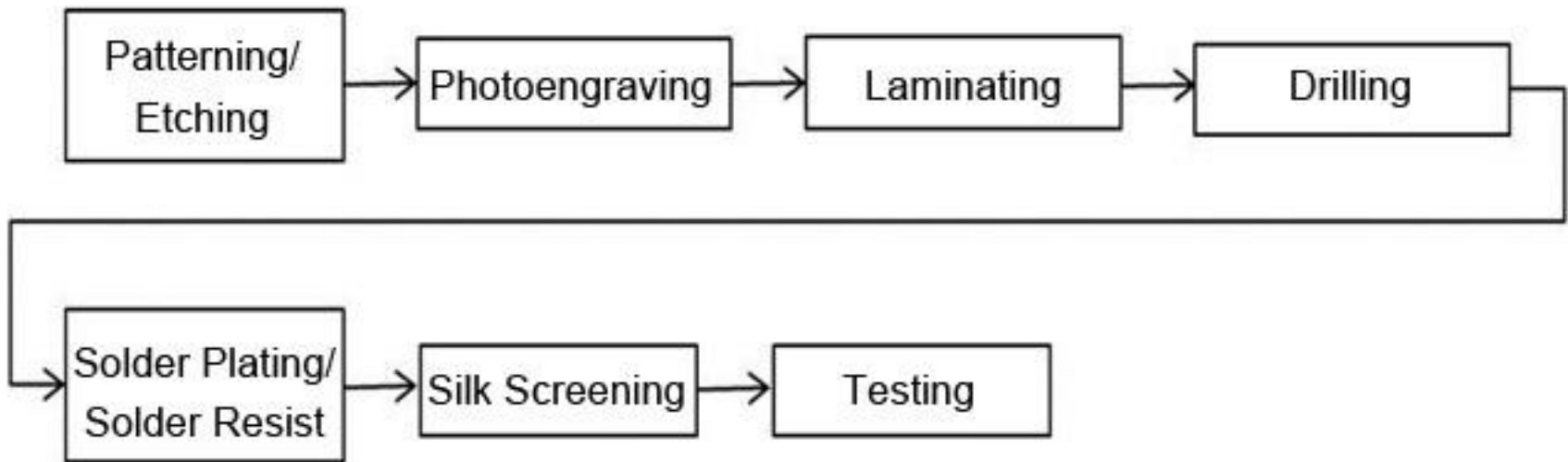

What's a Schematic?

- Schematic sheet is like what you draw to design a circuit on a piece of paper.
- You can see an example of a Schematic. (circuit of a CE amplifier with feedback for microphone input)

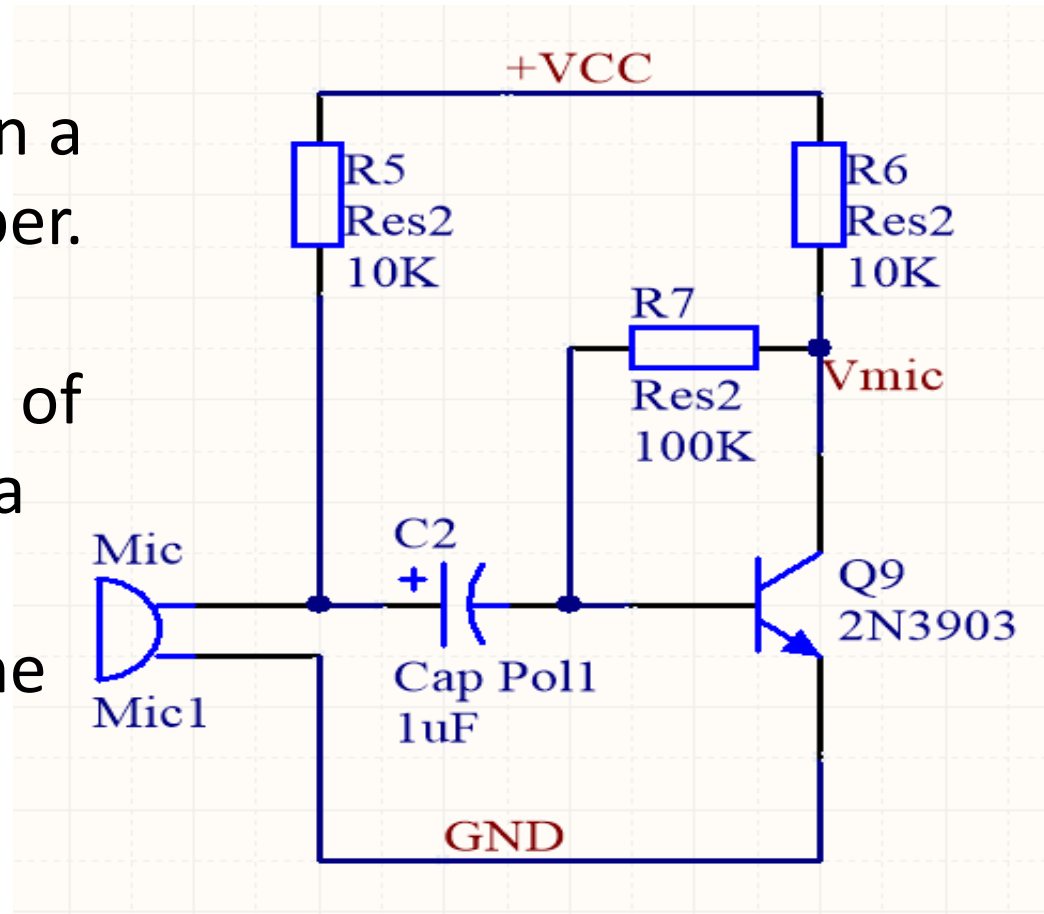

Creating PCB project

- Open the program. go to: **File\New\Project.**
- Select the options as you see, rename it and click **OK.**

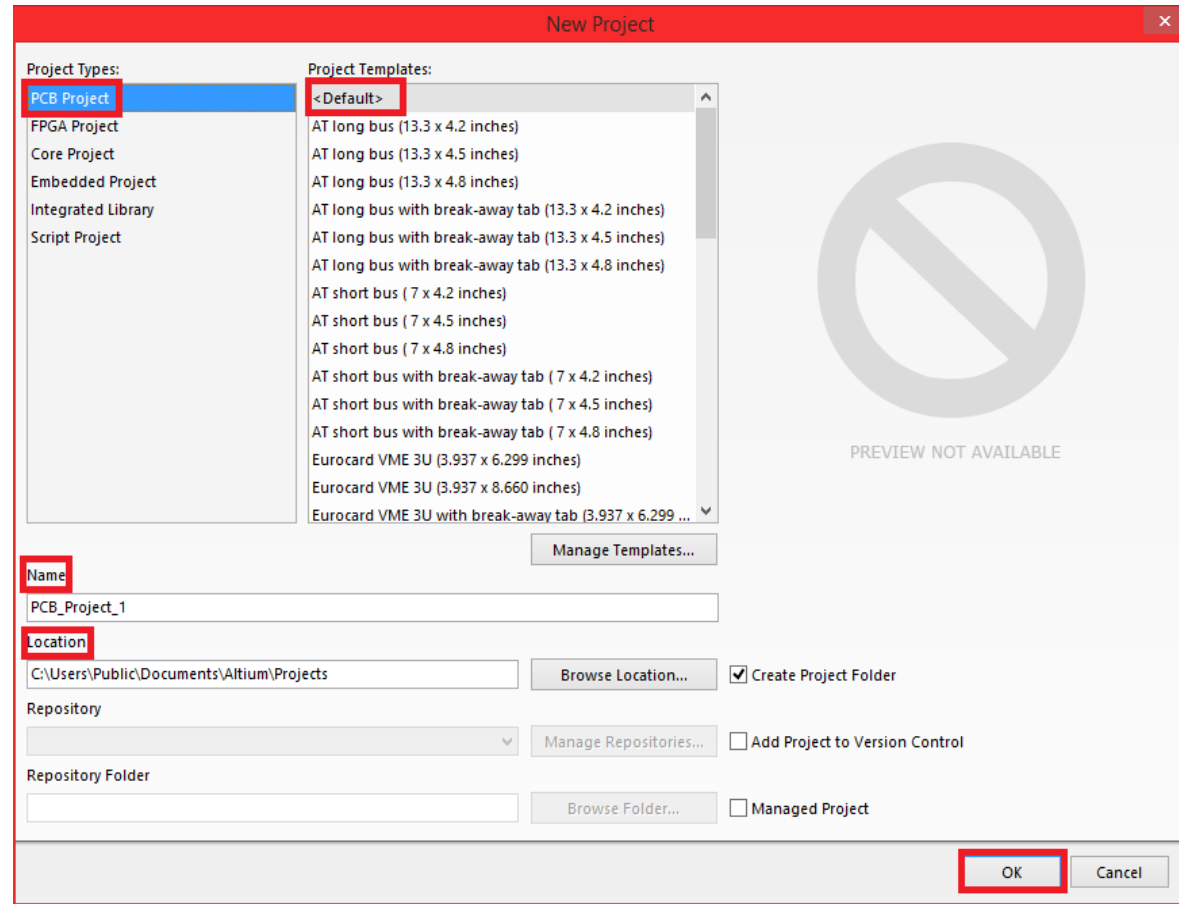

Creating Schematic

- Select **Projects** from the side toolbar.
- Right click on your PCB project.
- For creating a Schematic sheet, go to: **Add New to Project\Schematic**

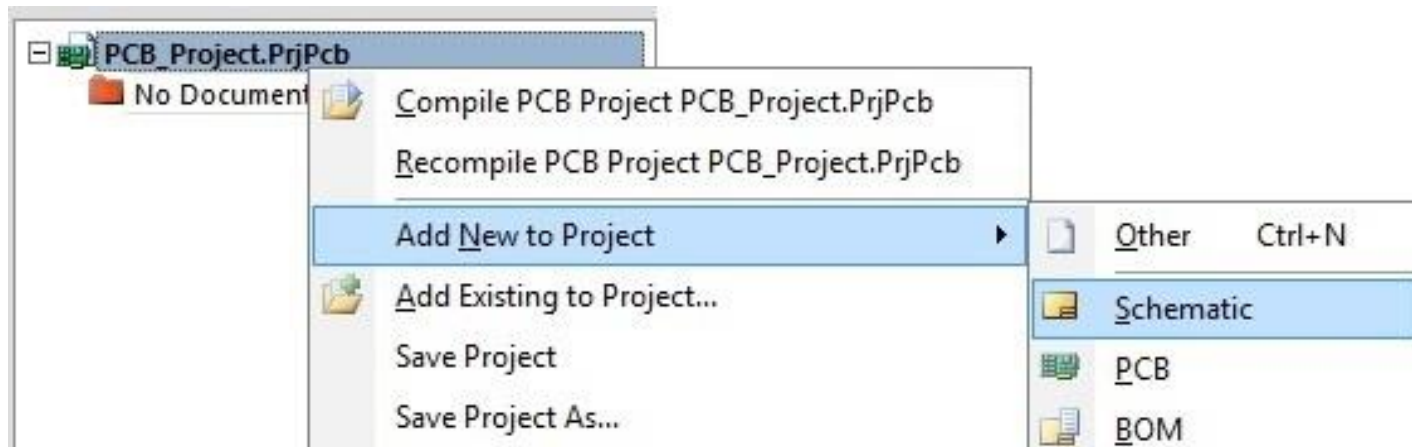

Creating PCB

- ❖ From the side toolbar (**Files**), select **PCB Board Wizard** from **New from template** section.

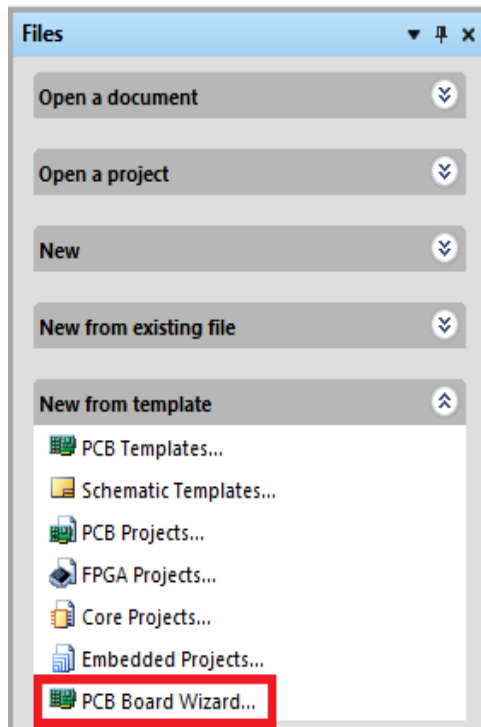

- ❖ Click **Next >**.

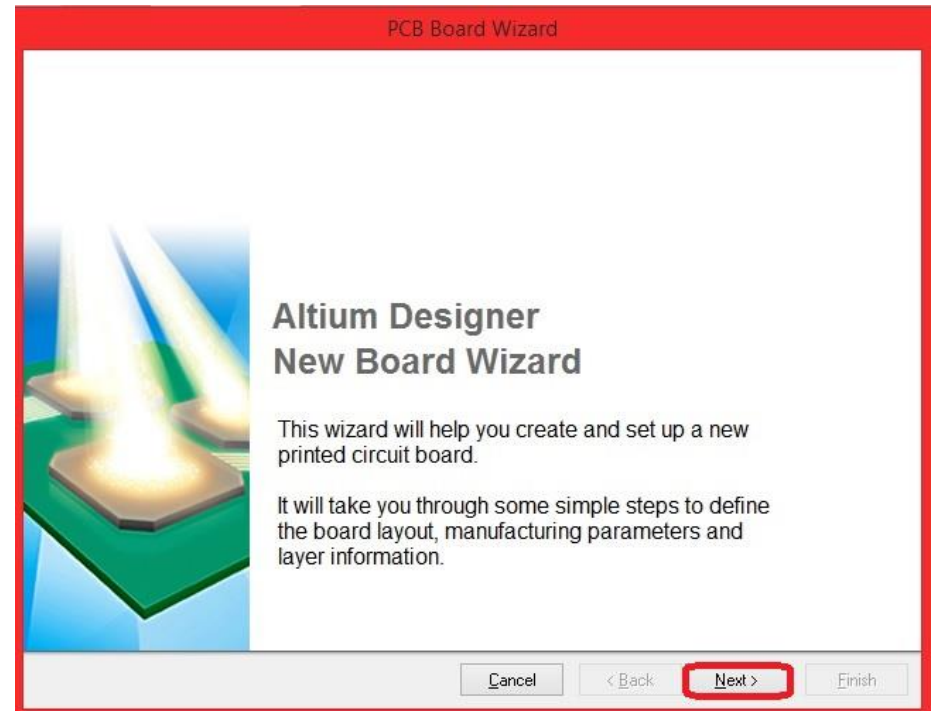

Creating PCB

- ❖ Choose **Metric** from **Board Units**. Click **Next >**.

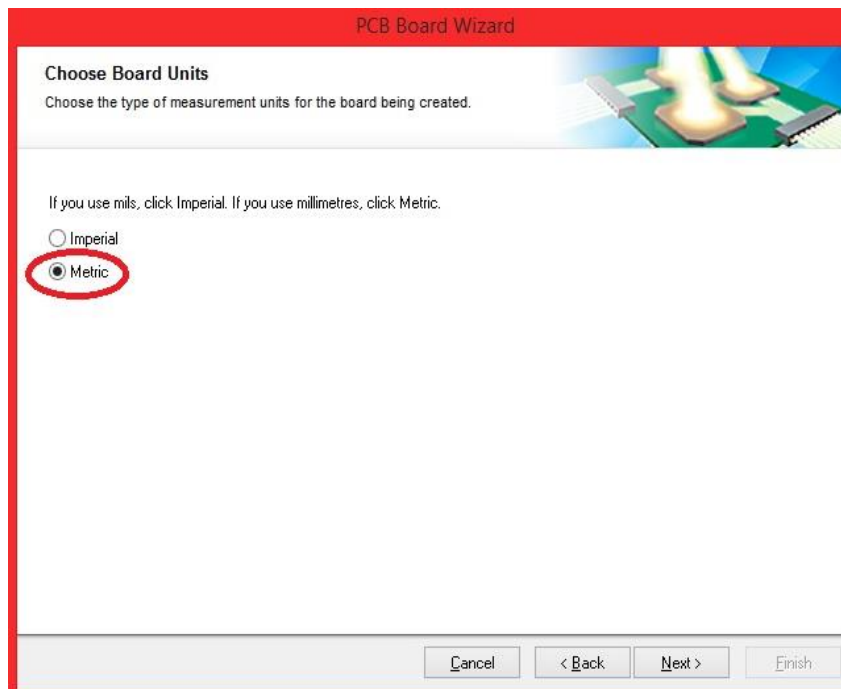

- ❖ Choose **A4** from **Board Profiles**. Click **Next >**.

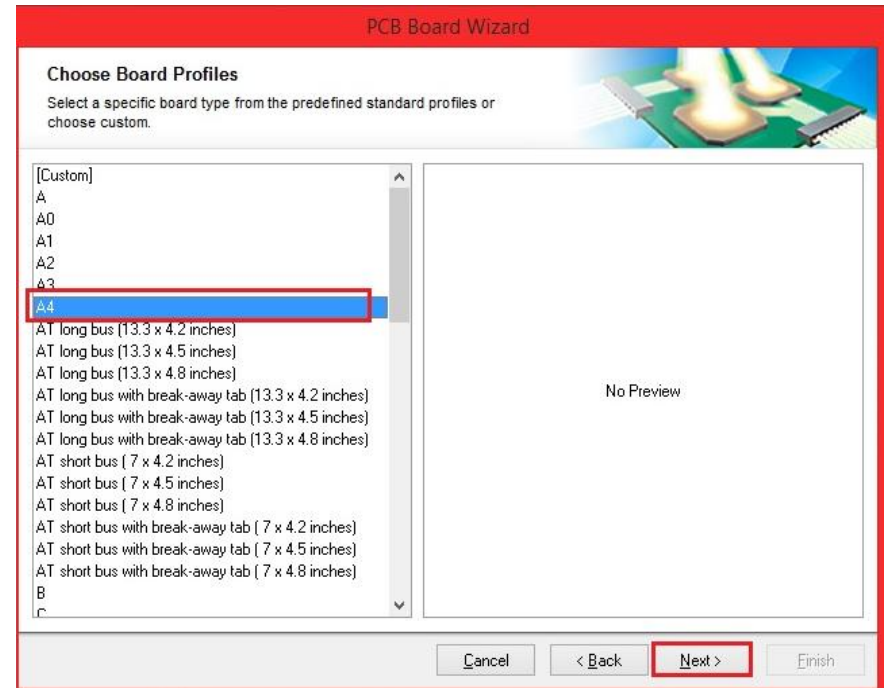

Creating PCB

- ❖ Set **Signal Layers** to **2** and **Power Planes** to **0**. Click **Next >**.

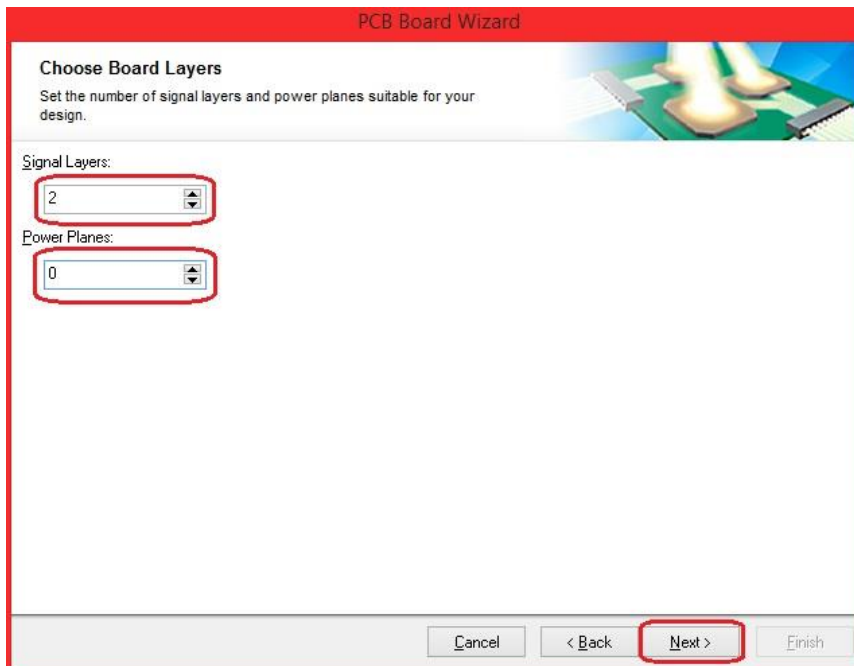

The screenshot shows the 'Choose Board Layers' dialog box in the PCB Board Wizard. The title bar reads 'PCB Board Wizard'. Below the title bar, the text 'Choose Board Layers' is followed by the instruction 'Set the number of signal layers and power planes suitable for your design.' There are two dropdown menus: 'Signal Layers' with the value '2' and 'Power Planes' with the value '0'. At the bottom, there are four buttons: 'Cancel', '< Back', 'Next >', and 'Finish'. The 'Next >' button is highlighted with a red box.

- ❖ Choose **Thruhole Vias Only** from **Via Style**. Click **Next >**.

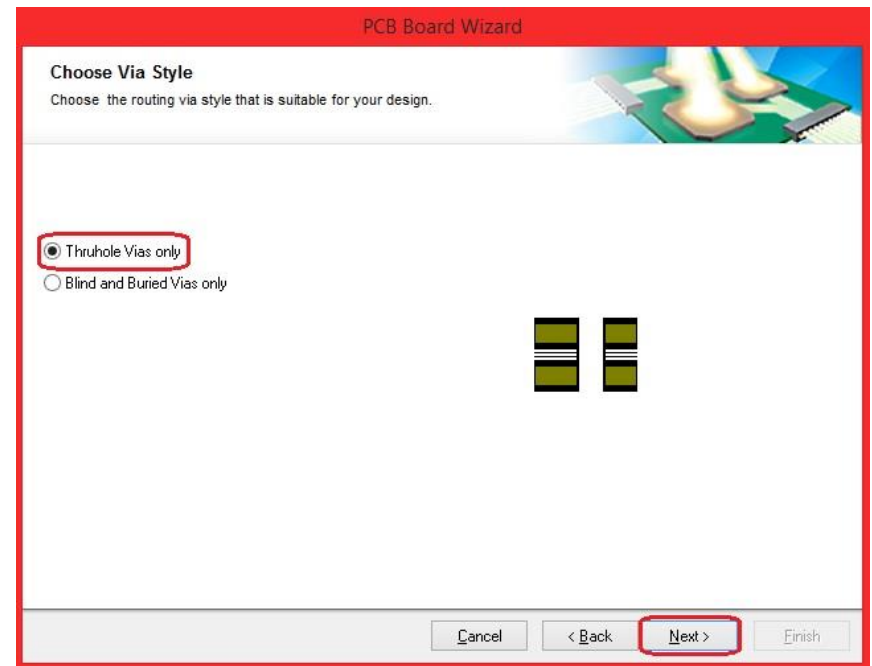

The screenshot shows the 'Choose Via Style' dialog box in the PCB Board Wizard. The title bar reads 'PCB Board Wizard'. Below the title bar, the text 'Choose Via Style' is followed by the instruction 'Choose the routing via style that is suitable for your design.' There are two radio button options: 'Thruhole Vias only' (which is selected) and 'Blind and Buried Vias only'. Below the options, there are two small diagrams of vias. At the bottom, there are four buttons: 'Cancel', '< Back', 'Next >', and 'Finish'. The 'Next >' button is highlighted with a red box.

Creating PCB

- ❖ Choose **Through-hole components** and then **One Track**.

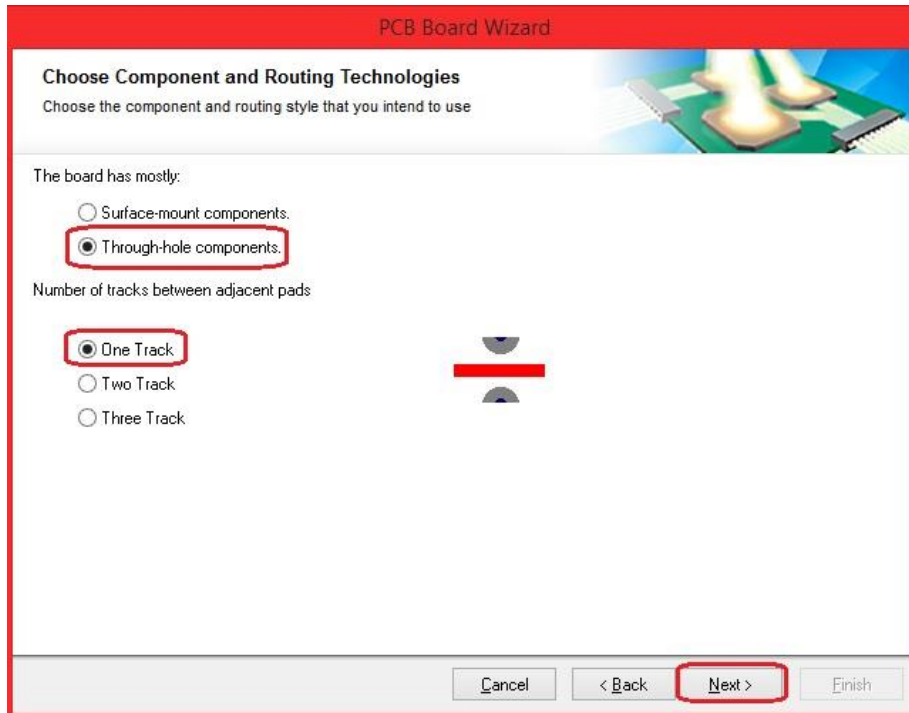

- ❖ Click **Next >** twice then **Finish**.

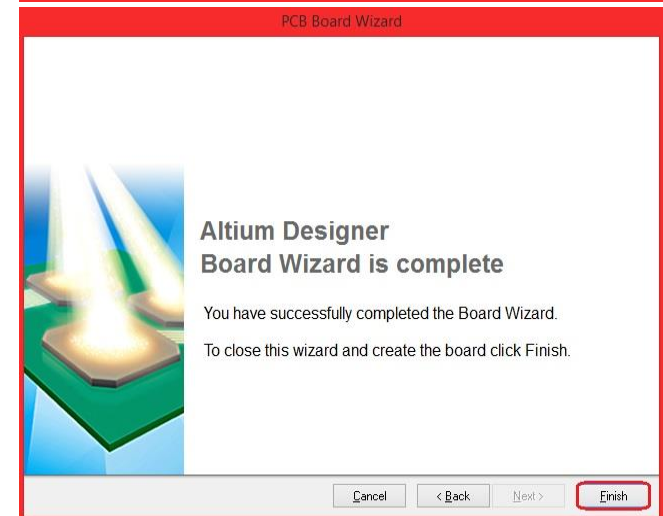
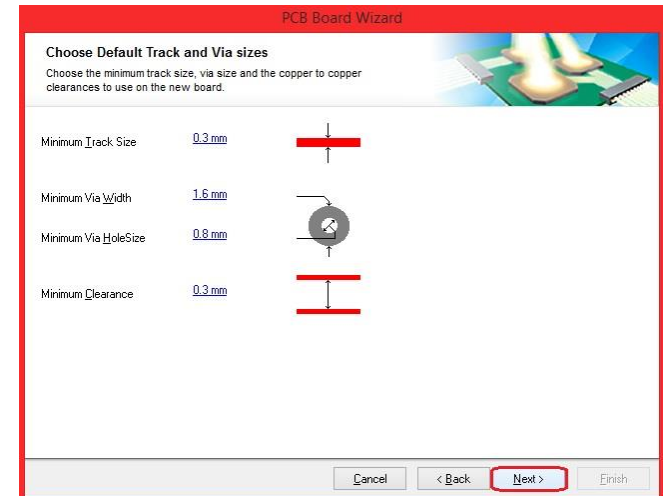

Adding Libraries

- ❑ After installing Altium Designer, you should install the libraries that include various devices needed in your Design (like resistors, capacitors, transistors, regulators, ...).
- ❑ Libraries can be found at:
<http://techdocs.altium.com/display/ADOH/Download+Libraries>
- ❑ Usually libraries belong to different manufacturing companies and contain their production.

Adding Libraries

- Go to: **Design\Add/Remove Library\install\install from file.**

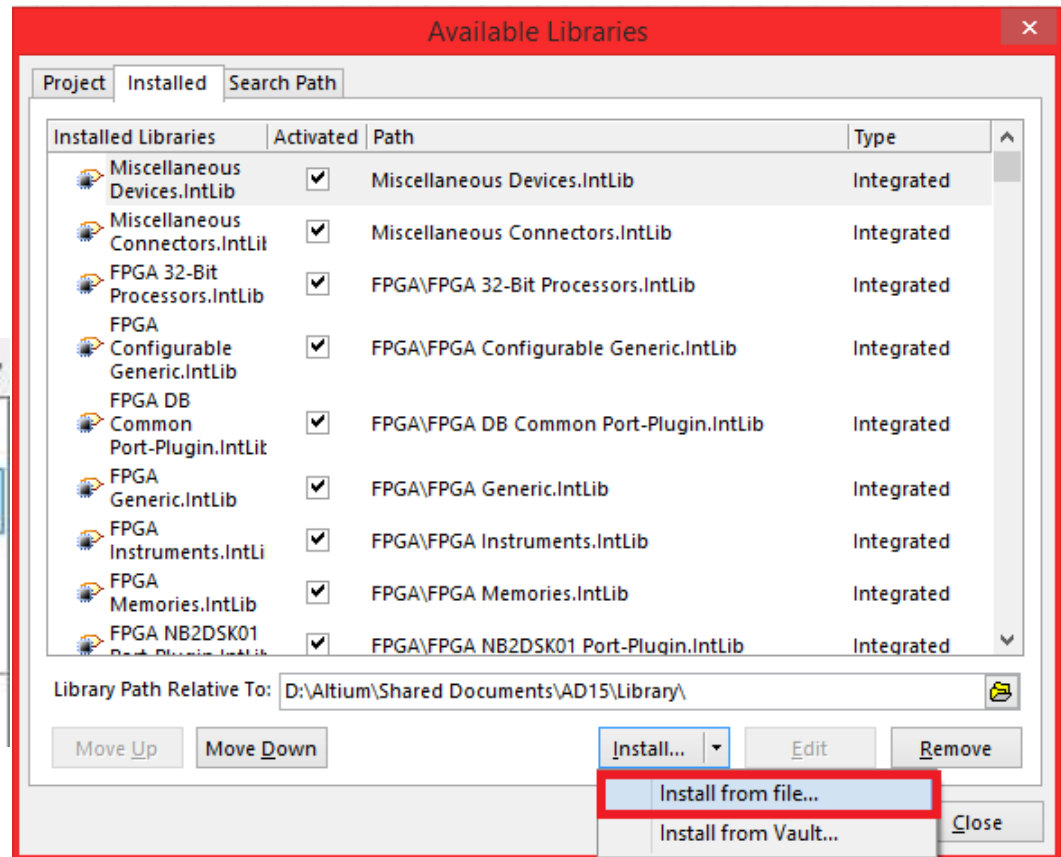
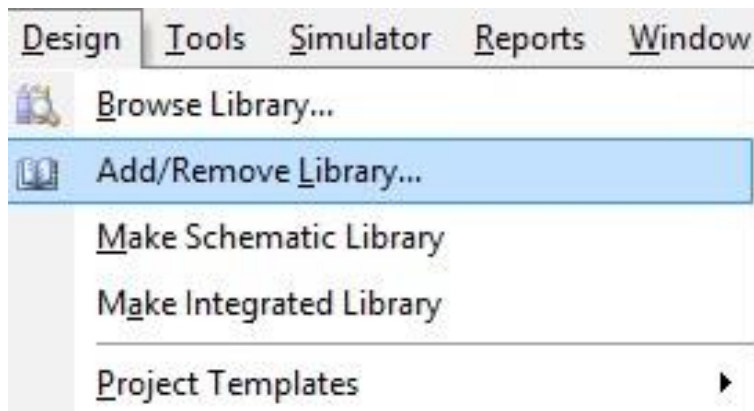

Adding Libraries

- Select the downloaded libraries and click **Open.**

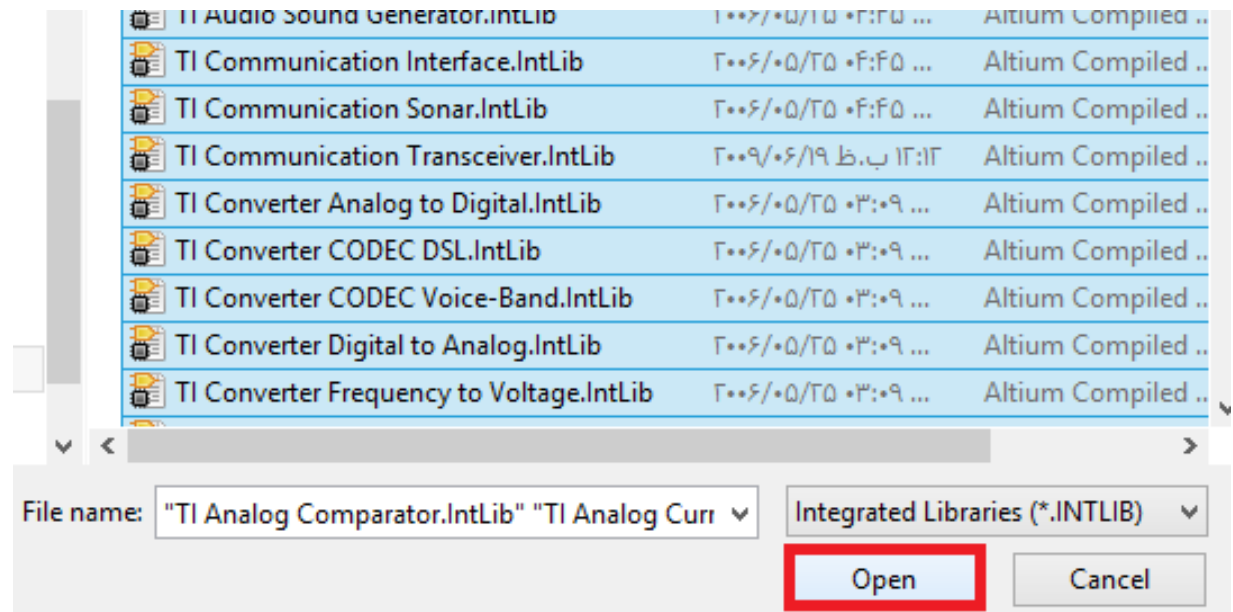

- Libraries should be installed by now.

Designing Schematics

- Before starting to work on Schematics, you should know which devices you are going to use and how they are connected.
- Choose the Schematic sheet which you created before.
- At the top, there is a designing toolbar.

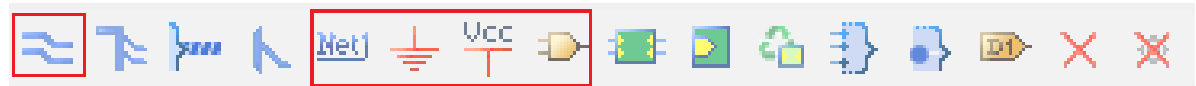

- You probably won't need most of them. In your project, you'll mostly need **Place Wire**, **Place Net Label**, **GND** and **VCC** symbol and **Place Part** (you'll also find these tools in **Design** at top).

Designing Schematics

- Let's start by placing parts.
- For placing a part, you must have installed the libraries and also you must know which company makes that part.
- Go to: **Place\Part\Choose.**

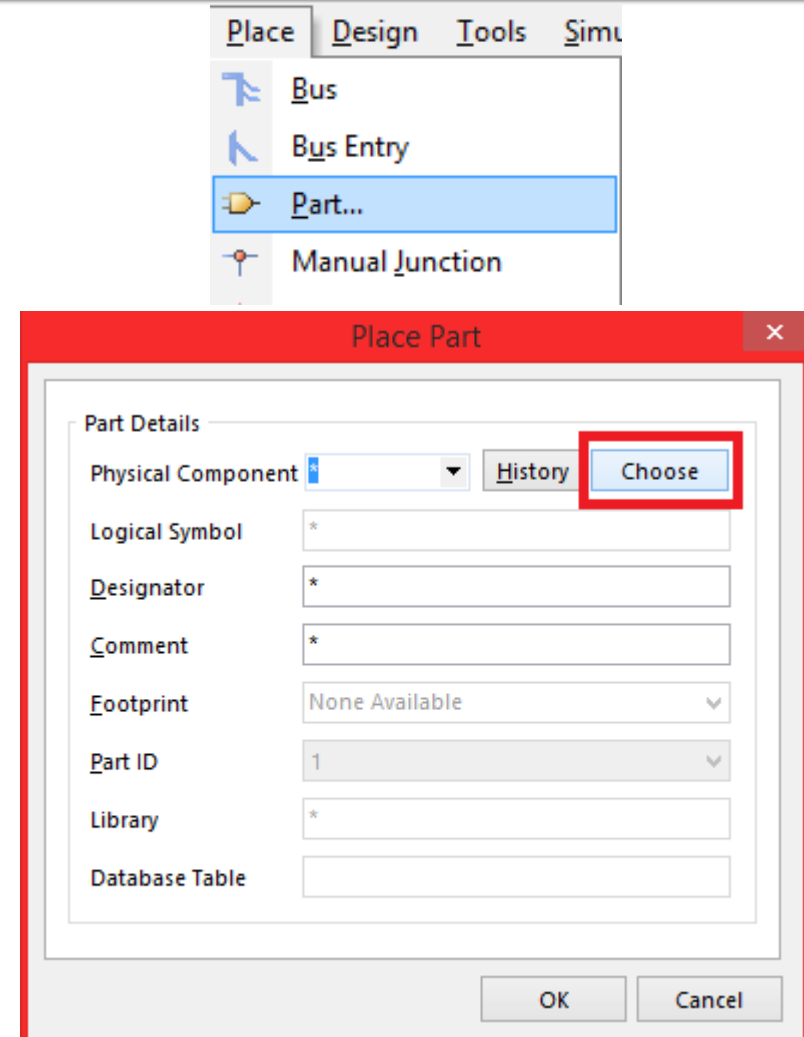

Designing Schematics

- Select the library you want to place part from and select the part.

 **Important Note:** be sure that selected parts, have valid **footprints!**

- Footprint defines the location of a device and therefore the location of pins and their holes' sizes on PCB.

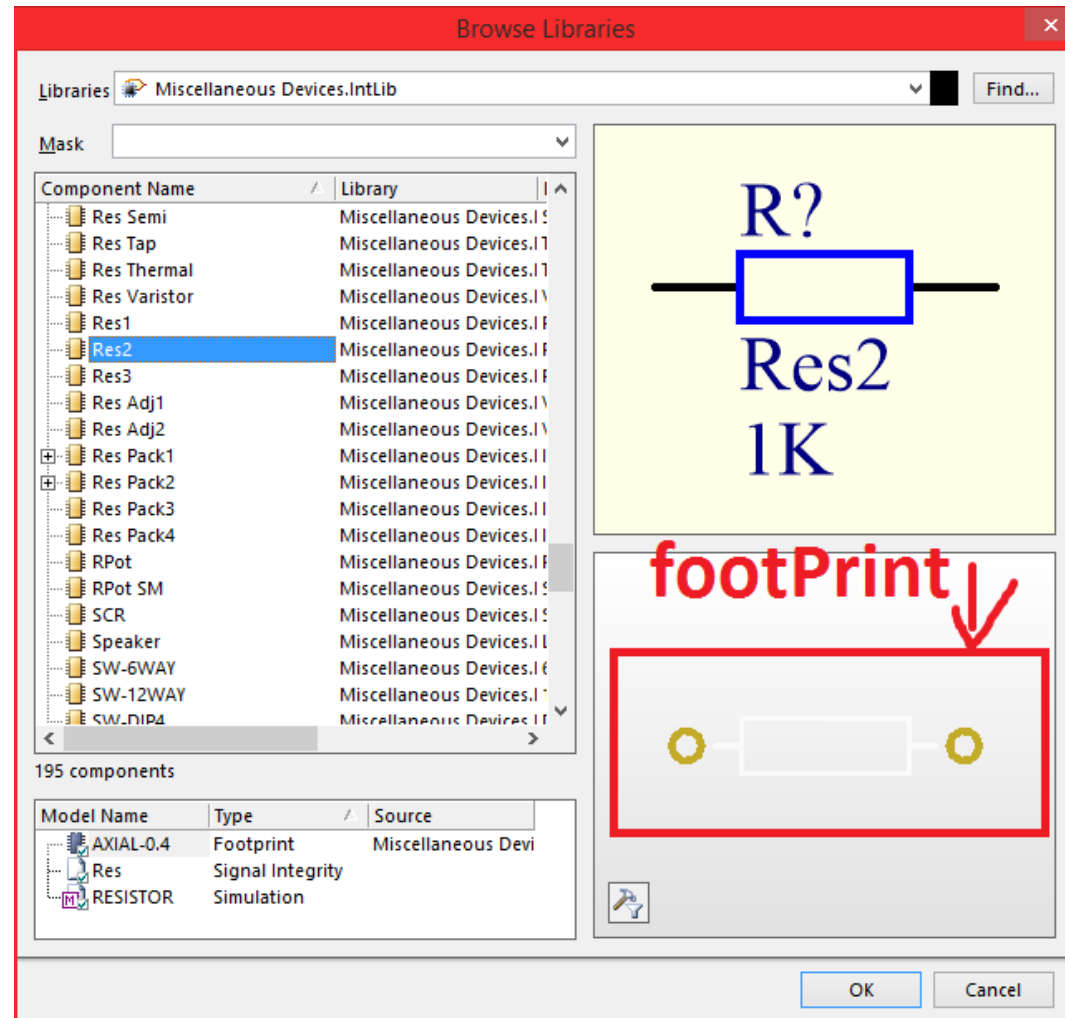

Designing Schematics

- Put the device in Schematic.
- Double-click on the name.
- Rename the device in **Parameter properties**.
- 💡 **Tip:** Always rename the devices.
- 📝 **Note:** For rotating the device, press **space** key while dragging the device.

The screenshot shows the 'Parameter Properties' dialog box for a device. The 'Name' field is set to 'Designator' and the 'Value' field is set to 'R1'. The 'Visible' checkbox is checked and the 'Lock' checkbox is unchecked for both fields. The 'Properties' section includes: Location X (350), Location Y (644), Color (dark blue), Type (STRING), Font (Times New Roman, 10), Orientation (0 Degrees), Justification (Bottom, Left), Unique ID (NKDGLTJI), and checkboxes for 'Allow Synchronization With Database' and 'Allow Synchronization With Library', all of which are checked. The 'Autoposition' checkbox is also checked. The 'OK' button is highlighted with a red box.



Designing Schematics

- You can change the value of a device by double-clicking on the value.

 **Tip: Check the datasheet of the part first!**

- You can find basic electronic devices like Resistor, Capacitor and... in **Miscellaneous +Devices.IntLib** Library.

Designing Schematics

- Now that parts are placed, they need to be connected. For that you can use Wires or Net Labels.
-  **Tip:** divide your circuit into different areas and use wire for connections inside areas and use Net Label for connections between areas.
-  **Note:** Nets with same label are connected to each other.
-  **Tip:** Try to use Net Label more often (but not so much) in your designs, because it increases your circuit's readability.

Designing Schematics

- After putting a **Net Label** on the port, you can edit the **Net Label's** string by double clicking on it.
- 📝 **Note:** You can use 2-Pin Header for Power ports.
- 💡 **Tip:** Always use Net Label for GND and VCC nets. It will take much less space.
- 💡 **Tip:** Always make sure that wires and net labels are not in the air!
- 📝 **Note:** Make sure the devices don't have same names.

Designing Schematics

- Now we're going to design this Schematic. Pay attention to Video:

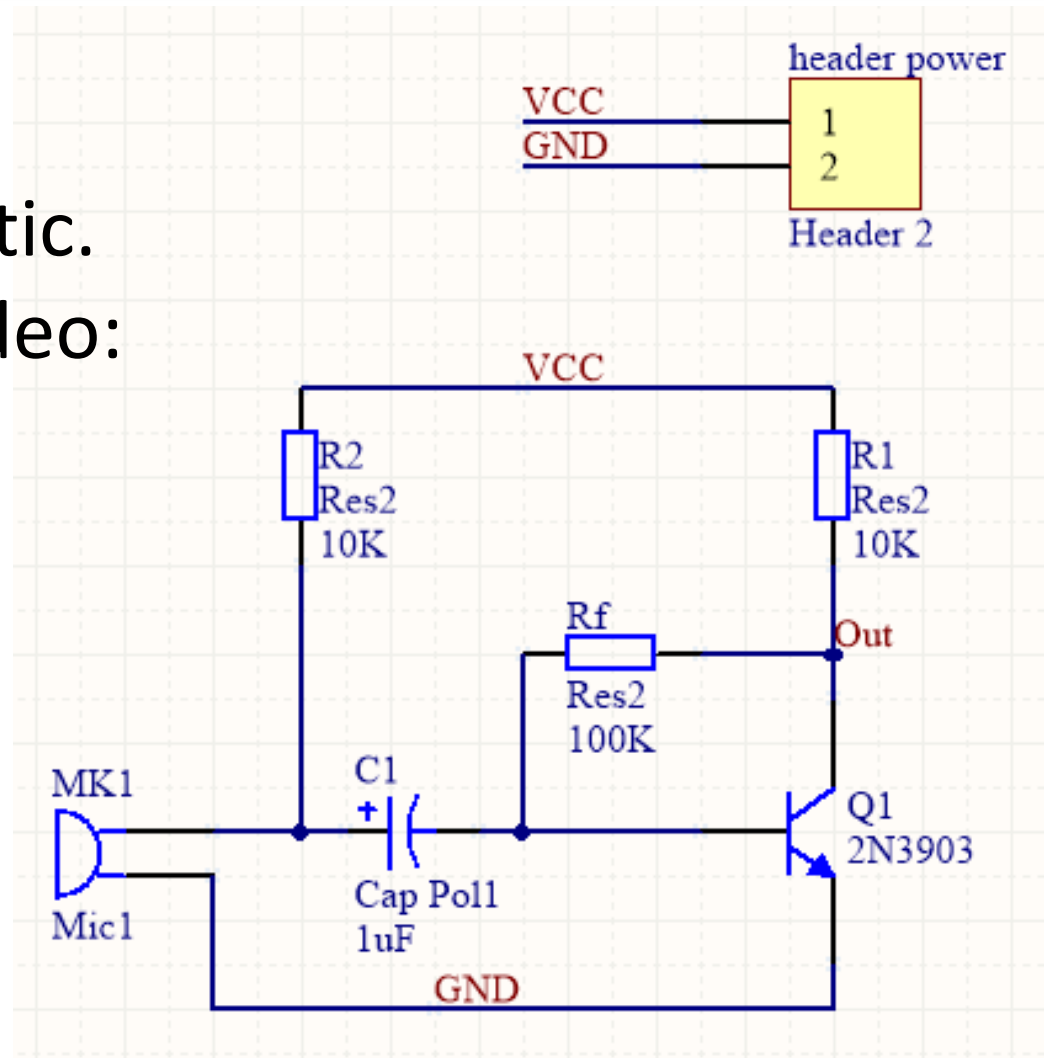

Designing Schematics

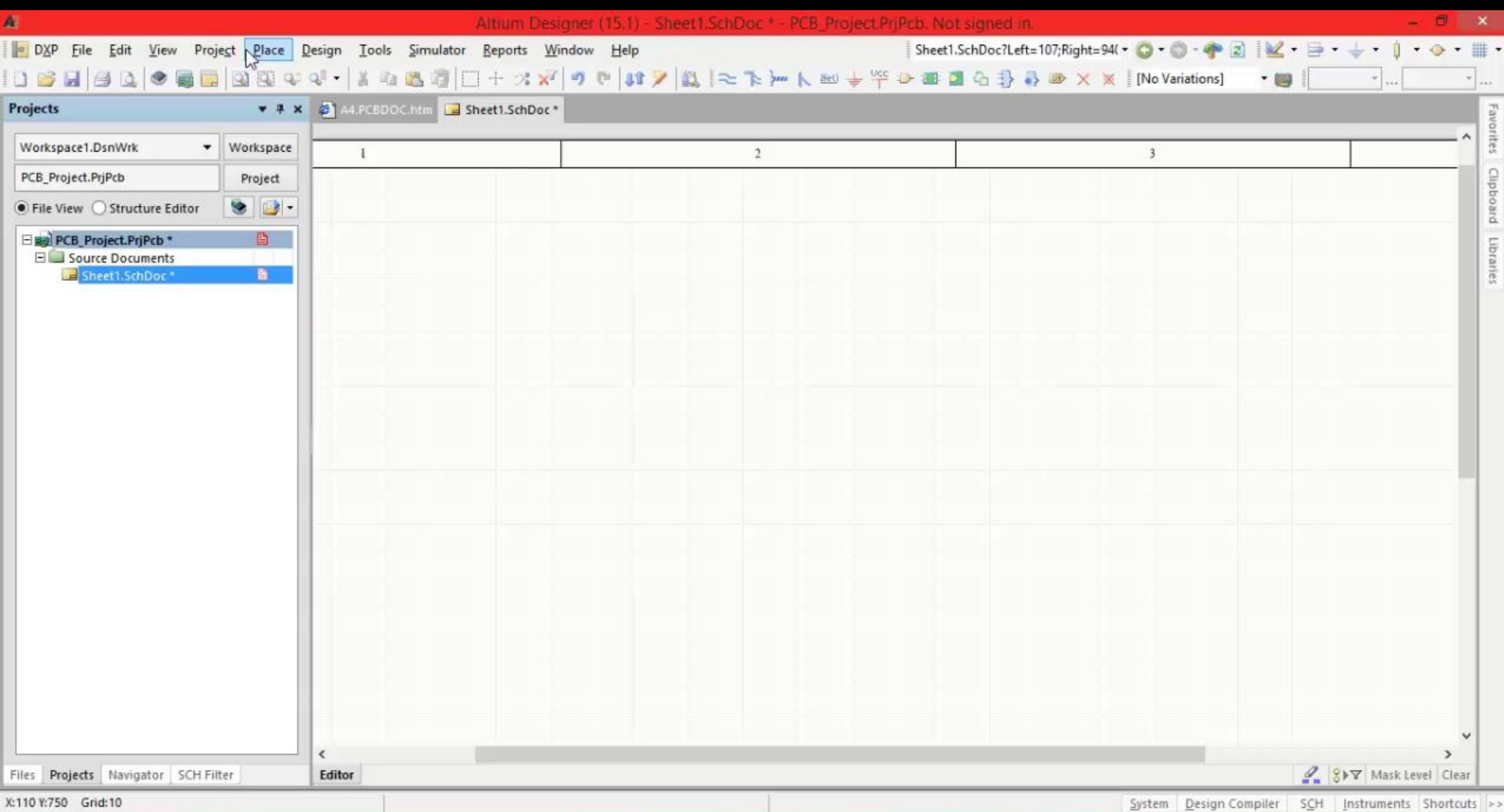

Designing PCB

- ❖ After creating PCB file, both PCB and Schematic files must be added to the same project.
- ❖ Go to: **Design\ Import Changes from PCB_Project.PrjPcb**

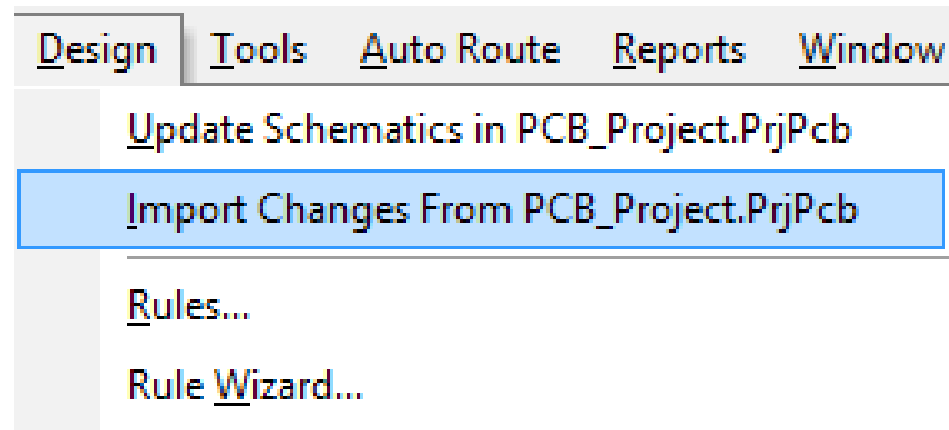

Designing PCB

- Now click **Validate Changes**:

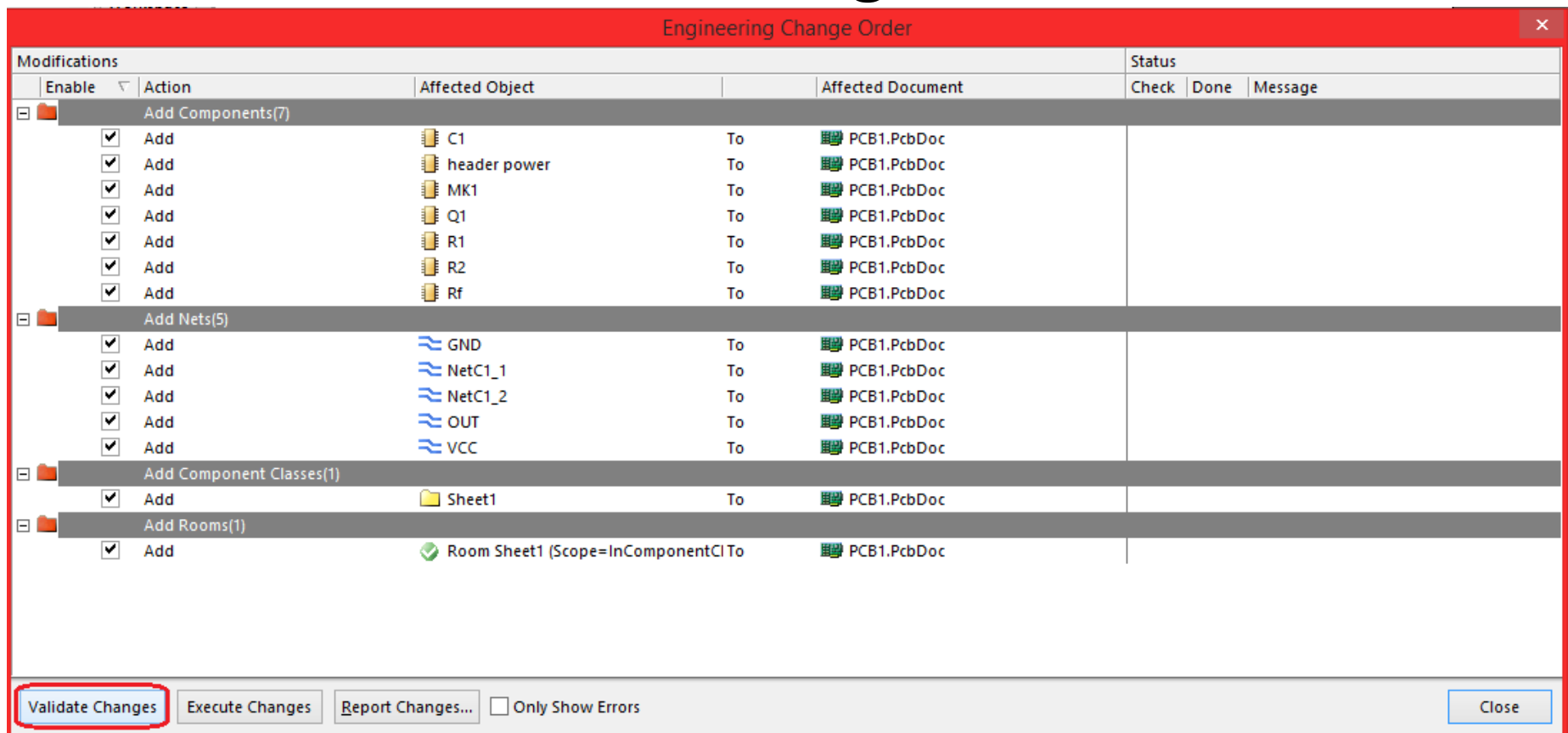

The screenshot shows the 'Engineering Change Order' dialog box. The 'Modifications' section is expanded, showing a list of changes. The 'Validate Changes' button is highlighted with a red box.

Modifications					Status		
Enable	Action	Affected Object		Affected Document	Check	Done	Message
Add Components(7)							
<input checked="" type="checkbox"/>	Add	C1	To	PCB1.PcbDoc			
<input checked="" type="checkbox"/>	Add	header power	To	PCB1.PcbDoc			
<input checked="" type="checkbox"/>	Add	MK1	To	PCB1.PcbDoc			
<input checked="" type="checkbox"/>	Add	Q1	To	PCB1.PcbDoc			
<input checked="" type="checkbox"/>	Add	R1	To	PCB1.PcbDoc			
<input checked="" type="checkbox"/>	Add	R2	To	PCB1.PcbDoc			
<input checked="" type="checkbox"/>	Add	Rf	To	PCB1.PcbDoc			
Add Nets(5)							
<input checked="" type="checkbox"/>	Add	GND	To	PCB1.PcbDoc			
<input checked="" type="checkbox"/>	Add	NetC1_1	To	PCB1.PcbDoc			
<input checked="" type="checkbox"/>	Add	NetC1_2	To	PCB1.PcbDoc			
<input checked="" type="checkbox"/>	Add	OUT	To	PCB1.PcbDoc			
<input checked="" type="checkbox"/>	Add	VCC	To	PCB1.PcbDoc			
Add Component Classes(1)							
<input checked="" type="checkbox"/>	Add	Sheet1	To	PCB1.PcbDoc			
Add Rooms(1)							
<input checked="" type="checkbox"/>	Add	Room Sheet1 (Scope=InComponentCl To		PCB1.PcbDoc			

Buttons: **Validate Changes** (highlighted), Execute Changes, Report Changes..., Only Show Errors, Close

Designing PCB

- Now click **Execute Changes**:

The screenshot shows the 'Engineering Change Order' dialog box with a table of modifications. The 'Execute Changes' button is highlighted with a red box.

Engineering Change Order							
Modifications					Status		
Enable	Action	Affected Object		Affected Document	Check	Done	Message
Add Components(7)							
<input checked="" type="checkbox"/>	Add	C1	To	PCB1.PcbDoc	<input checked="" type="checkbox"/>		
<input checked="" type="checkbox"/>	Add	header power	To	PCB1.PcbDoc	<input checked="" type="checkbox"/>		
<input checked="" type="checkbox"/>	Add	MK1	To	PCB1.PcbDoc	<input checked="" type="checkbox"/>		
<input checked="" type="checkbox"/>	Add	Q1	To	PCB1.PcbDoc	<input checked="" type="checkbox"/>		
<input checked="" type="checkbox"/>	Add	R1	To	PCB1.PcbDoc	<input checked="" type="checkbox"/>		
<input checked="" type="checkbox"/>	Add	R2	To	PCB1.PcbDoc	<input checked="" type="checkbox"/>		
<input checked="" type="checkbox"/>	Add	Rf	To	PCB1.PcbDoc	<input checked="" type="checkbox"/>		
Add Nets(5)							
<input checked="" type="checkbox"/>	Add	GND	To	PCB1.PcbDoc	<input checked="" type="checkbox"/>		
<input checked="" type="checkbox"/>	Add	NetC1_1	To	PCB1.PcbDoc	<input checked="" type="checkbox"/>		
<input checked="" type="checkbox"/>	Add	NetC1_2	To	PCB1.PcbDoc	<input checked="" type="checkbox"/>		
<input checked="" type="checkbox"/>	Add	OUT	To	PCB1.PcbDoc	<input checked="" type="checkbox"/>		
<input checked="" type="checkbox"/>	Add	VCC	To	PCB1.PcbDoc	<input checked="" type="checkbox"/>		
Add Component Classes(1)							
<input checked="" type="checkbox"/>	Add	Sheet1	To	PCB1.PcbDoc	<input checked="" type="checkbox"/>		
Add Rooms(1)							
<input checked="" type="checkbox"/>	Add	Room Sheet1 (Scope=InComponentCl To		PCB1.PcbDoc	<input checked="" type="checkbox"/>		

Buttons: Validate Changes, **Execute Changes**, Report Changes..., Only Show Errors, Close

Designing PCB

- Now click **Close**:

Engineering Change Order

Modifications					Status		
Enable	Action	Affected Object		Affected Document	Check	Done	Message
Add Components(7)							
<input checked="" type="checkbox"/>	Add	C1	To	PCB1.PcbDoc	✓	✓	
<input checked="" type="checkbox"/>	Add	header power	To	PCB1.PcbDoc	✓	✓	
<input checked="" type="checkbox"/>	Add	MK1	To	PCB1.PcbDoc	✓	✓	
<input checked="" type="checkbox"/>	Add	Q1	To	PCB1.PcbDoc	✓	✓	
<input checked="" type="checkbox"/>	Add	R1	To	PCB1.PcbDoc	✓	✓	
<input checked="" type="checkbox"/>	Add	R2	To	PCB1.PcbDoc	✓	✓	
<input checked="" type="checkbox"/>	Add	Rf	To	PCB1.PcbDoc	✓	✓	
Add Nets(5)							
<input checked="" type="checkbox"/>	Add	GND	To	PCB1.PcbDoc	✓	✓	
<input checked="" type="checkbox"/>	Add	NetC1_1	To	PCB1.PcbDoc	✓	✓	
<input checked="" type="checkbox"/>	Add	NetC1_2	To	PCB1.PcbDoc	✓	✓	
<input checked="" type="checkbox"/>	Add	OUT	To	PCB1.PcbDoc	✓	✓	
<input checked="" type="checkbox"/>	Add	VCC	To	PCB1.PcbDoc	✓	✓	
Add Component Classes(1)							
<input checked="" type="checkbox"/>	Add	Sheet1	To	PCB1.PcbDoc	✓	✓	
Add Rooms(1)							
<input checked="" type="checkbox"/>	Add	Room Sheet1 (Scope=InComponentCI To		PCB1.PcbDoc	✓	✓	

Validate Changes Execute Changes Report Changes... Only Show Errors **Close**

Designing PCB

- 📝 **Note:** Make sure that there is no error after the update.
- After importing, you can find the added parts inside the pink area, outside of PCB area (black area).

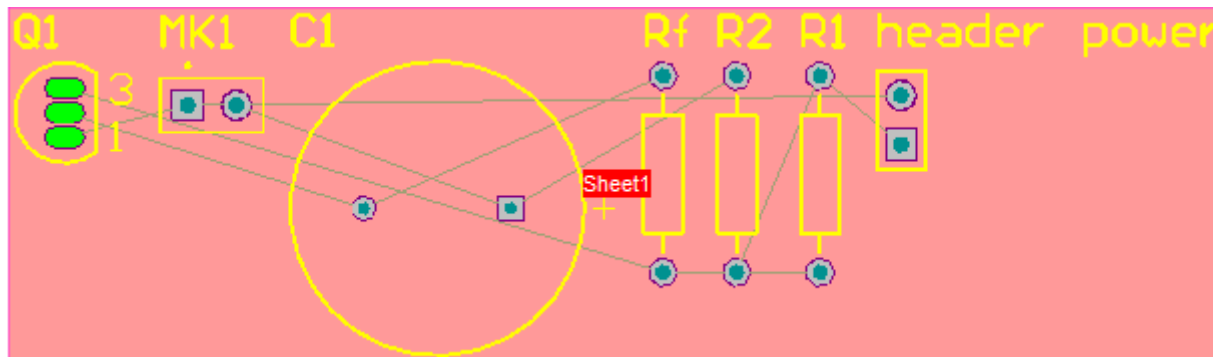

Designing PCB

- Put the devices in appropriate locations inside the black area.

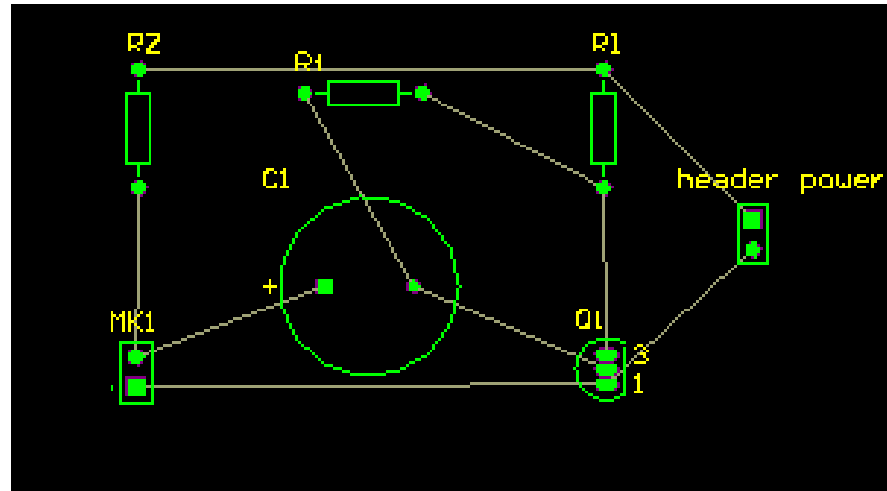

- Now you should connect devices with **Routes**.
- Routes** are conductive tracks connecting the holes.
- The best way is using **Auto-Route**.

Designing PCB

➤ Go to: Auto-Route\ All...

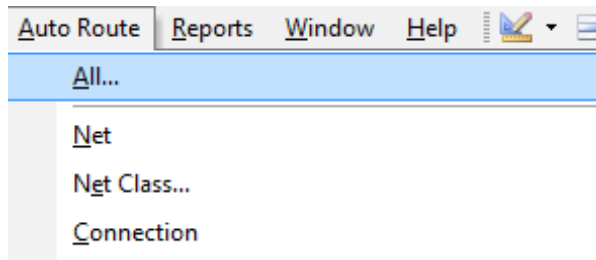

➤ Click **Edit Layer Directories**

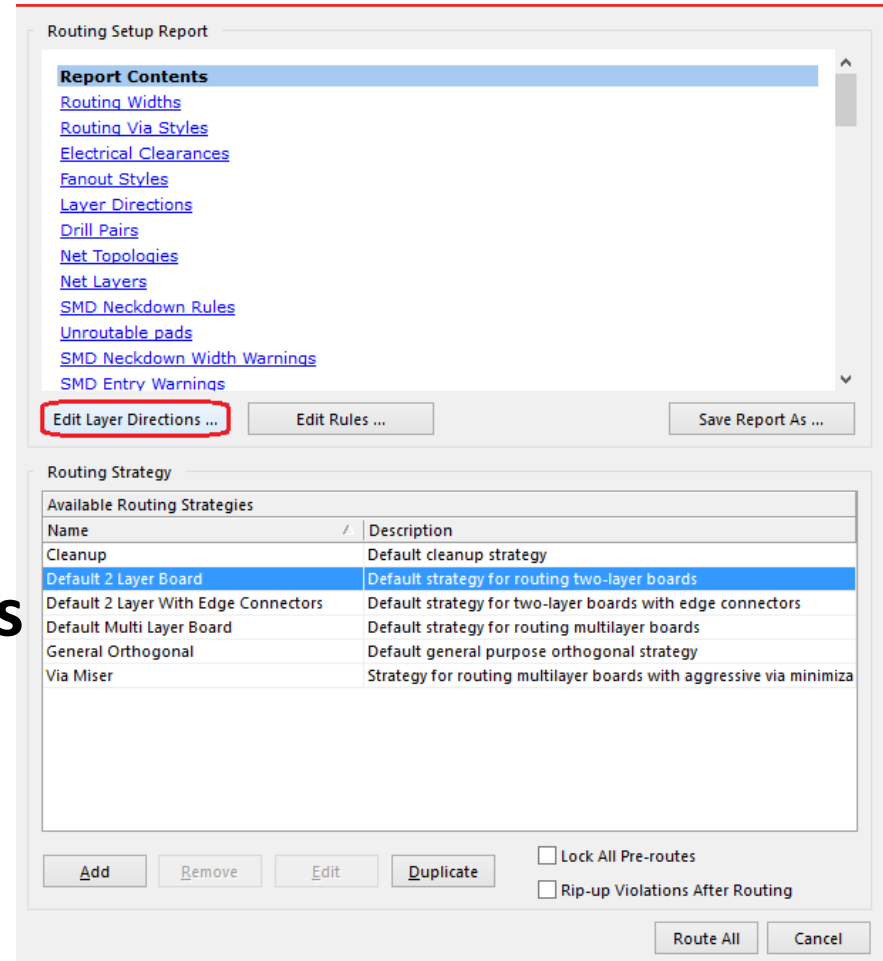

Designing PCB

- Click on **Current Setting** of **Top layer** and set its value to **Not Used**. Click **OK**.
 - Click **Route All**.
 - Your PCB should look like this:
-  **Note:** you can also manually modify routes by dragging them and using **Interactively Route Connections** .

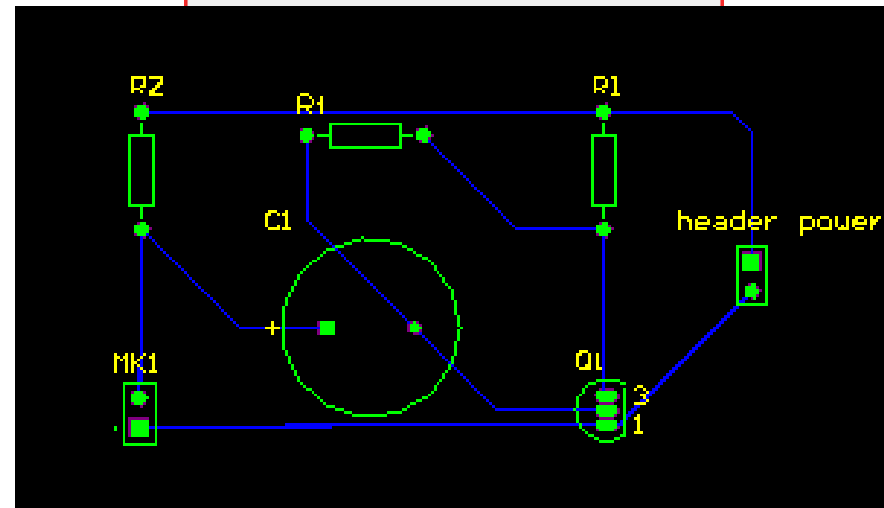
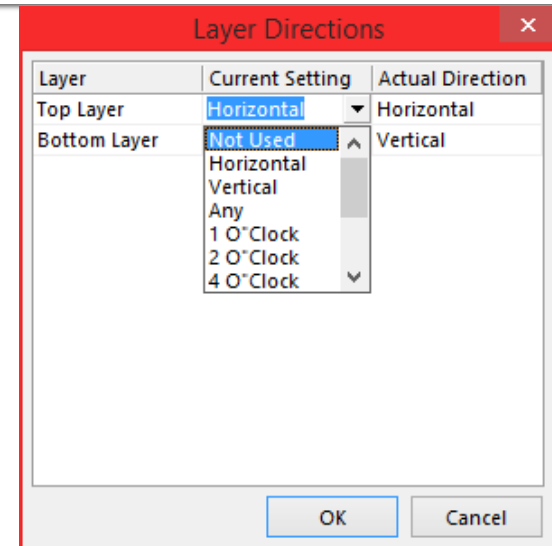

Designing PCB

- ❖ Now we're going to set the size of PCB.
- ❖ Select **Interactively Route Connections** from top toolbar.

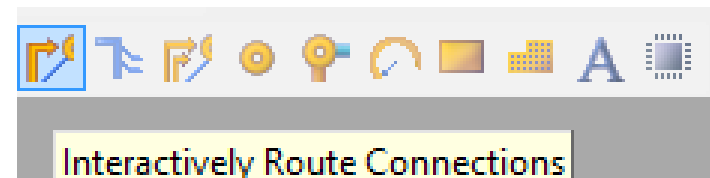

- ❖ Surround the devices by routes and make a rectangle like this: (red rectangle)

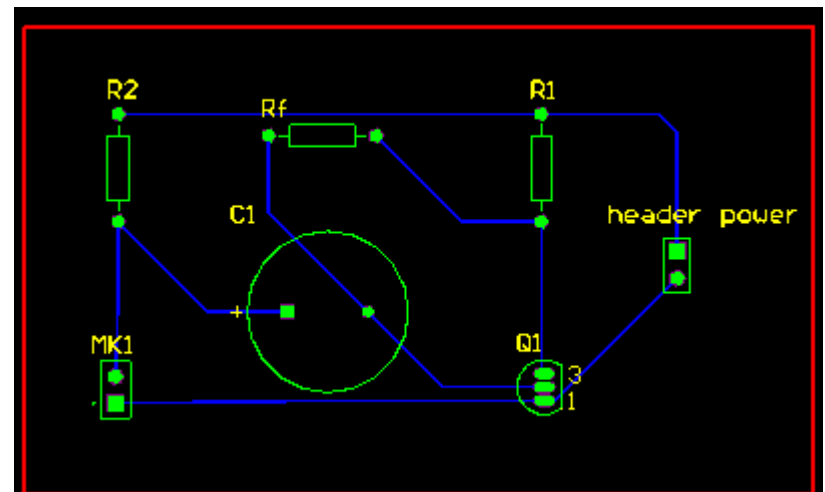

Designing PCB

- ❖ Double-click on routes and check **Locked** and **Keepout**.
- ❖ Your PCB should look like this: (surrounded by pink routes)

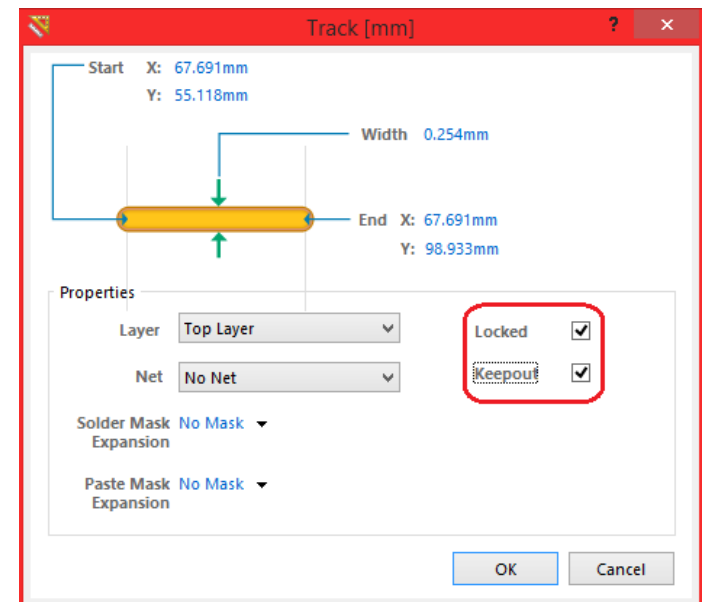
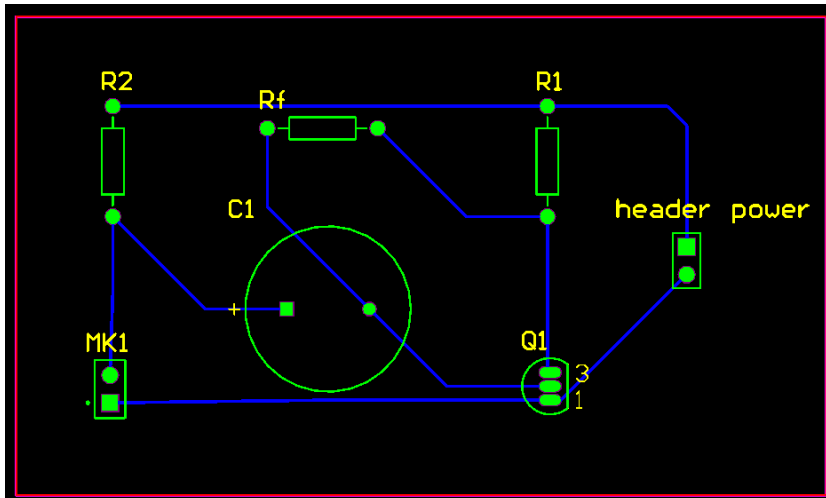

Designing PCB

- 📌 **Note:** Pink routes, are called Keep-out routes.
- Select all devices and routes (including Keepouts).
- Go to: **Design\ Board Shape\ Define from selected objects.**
- Click **Yes.**

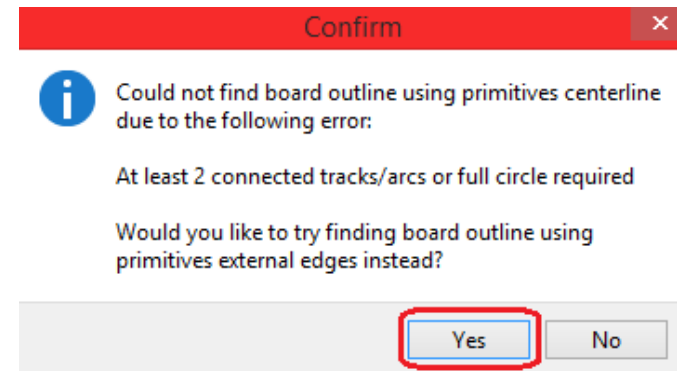
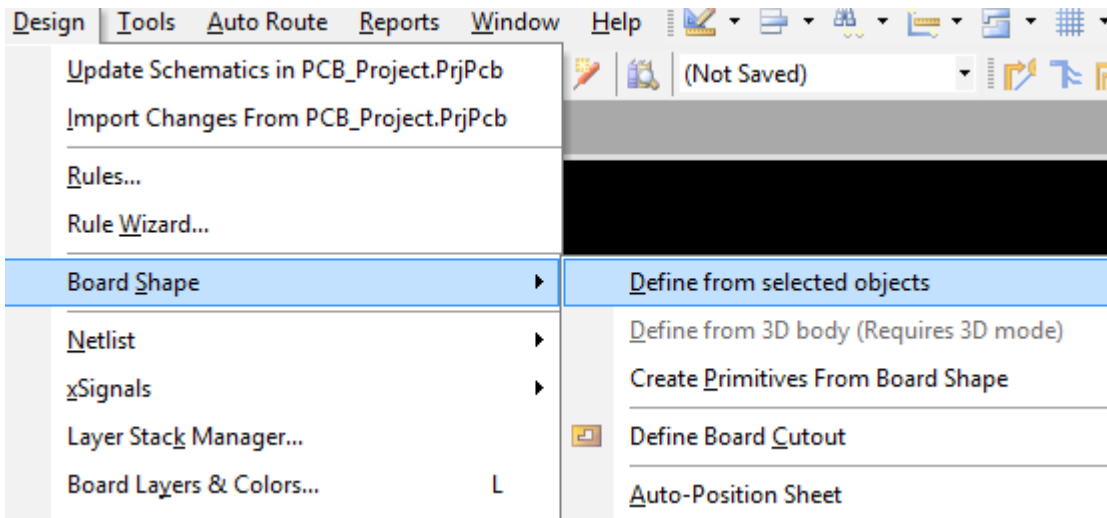

Designing PCB

- ❖ Now Your PCB should only have black areas only inside Keepouts, like this:

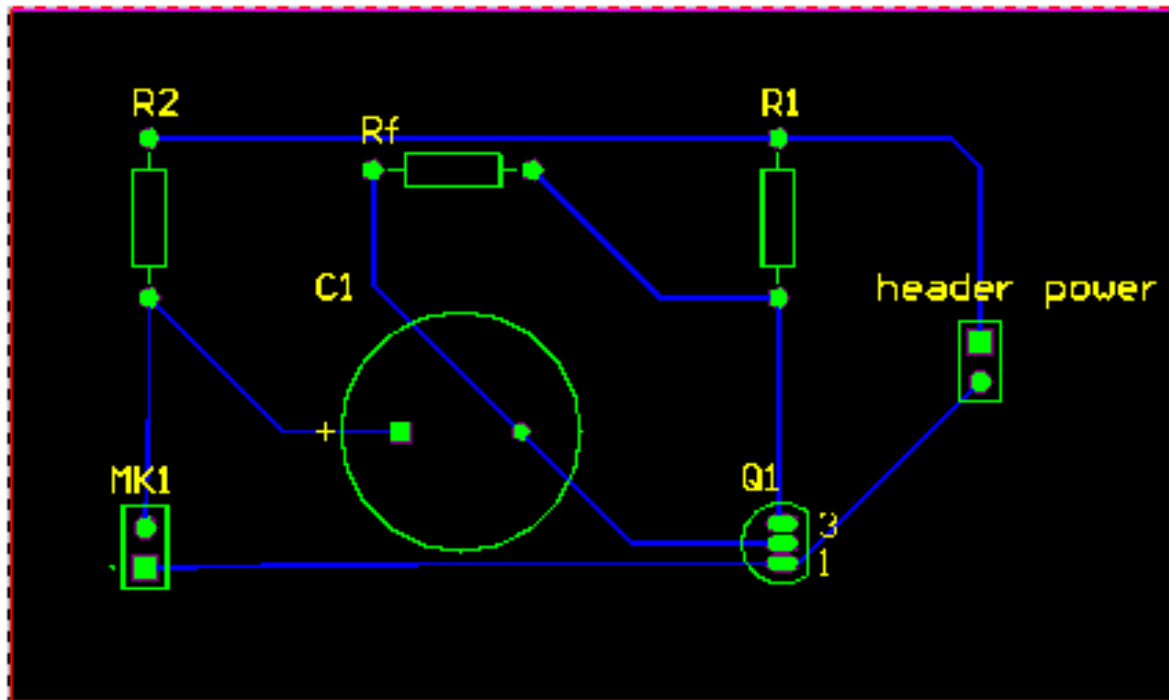

Common errors and tips

- Remember! any problem you run into in Altium can be found in internet. Look for answers in different forums.
- While opening a PCB file, you may get “**Please wait a moment**” crash. I solved this problem by running the program with **Integrated Graphics** of PC.
- Don't make your board too small. you'll have problem soldering the elements. Also don't put devices too close to each other.

Common errors and tips

- Errors while importing from Schematic to PCB are mostly caused by these:
 1. Some of your devices don't have valid footprints.
 2. You have some nets on air!
- You may not find your desired device in the libraries. In this case you should replace by a device which has the same footprint, so make sure size of the Pin-holes are the same.

Common errors and tips

- 💡 **Important Tip:** Make sure that routes on PCB, are not too close to holes.
- ❖ If necessary, you can change the size of the holes, by double clicking on the hole and editing the **Hole Size**.
- ❖ For new size holes, add 0.1 mm tolerance to diameter of the device's pin.
- ❖ Check web for answers!

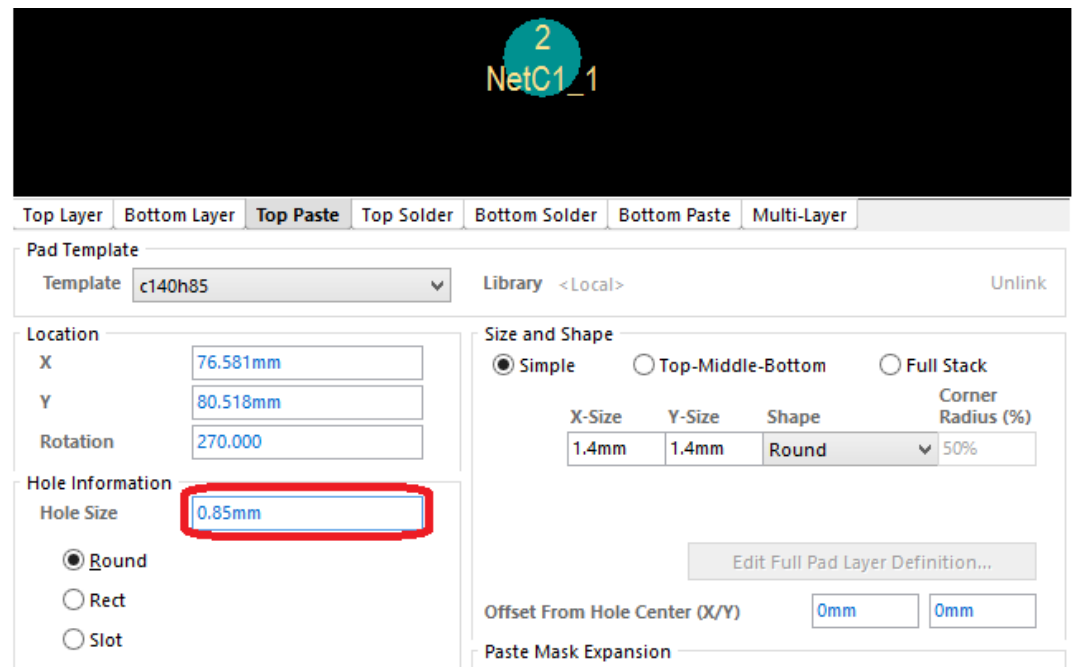

Common errors and tips

- ❖ You can change the width of a route too.
- ❖ This comes handy for routes that pass huge current. If you don't increase its width, then that route will just melt!
- ❖ To do so, just double-click on the route and change the width:

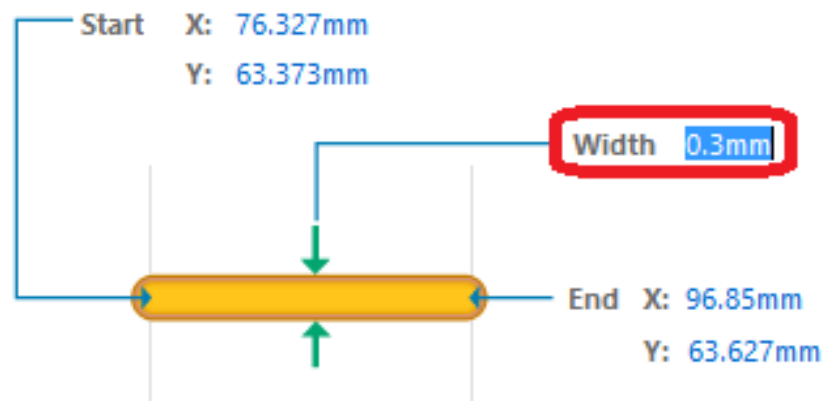

Guide to online ordering a PCB

- ❑ Try your best to make your PCB, a One layer PCB, so it will cost less. use only bottom routing (the blue one).
- ❑ It's not necessary to spend a lot of money on PCB, so try to choose cheaper options while ordering a PCB.
- ❑ Calculate width and height of the board by checking the coordinates (located at left-top of workspace) of board corners.

Guide to online ordering a PCB

□ Recommended options for simple PCB:

یک لایه	نوع مدار چاپی:
قاپیر گلاس	نوع قییر:
35 میکرون	ضخامت مس:
آبکاری قلع و سرب (فقط برای بردهای بدون چاپ محافظ)	پوشش نهایی:
ندارد	چاپ محافظ:
ندارد	رنگ چاپ محافظ:
ندارد	چاپ قطعات:
ندارد	رنگ چاپ قطعات:
1.6	ضخامت قییر مدار چاپی (میلیمتر):
80	طول برد (میلیمتر):
100	عرض برد (میلیمتر):
1	تعداد:
دستی	برش نهایی:

different for PCBs



References

- <https://www.wikipedia.org/>
- <https://learn.sparkfun.com/tutorials/pcb-basics>
- <http://www.altium.com/>

Contact

 If you have any questions, you can contact me by email with title of “Altium”.

 sharif.pelec@gmail.com

Thank you!